



INSTALLATION AND OPERATING INSTRUCTIONS

安裝使用說明書

Ventilating fan 換氣扇

Model No. 15WUF 07
型號：20WUF 07

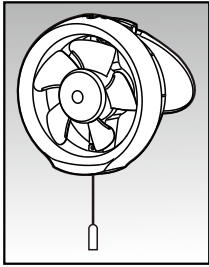

CONTENTS

SAFETY INSTRUCTIONS	2~3
INSTALLATION INSTRUCTIONS	3~4
INSTALLATION REQUIREMENTS	4~5
PART NAMES AND DIMENSIONS	5
HOW TO INSTALL	6
HOW TO USE	7
USE AND MAINTENANCE INSTRUCTIONS	7~8
MAINTENANCE	9
WIRING DIAGRAM	9
SPECIFICATIONS	BACK COVER

目錄

安全指引	2~3
安裝注意事項	3~4
安裝要求	4~5
部件名稱和尺寸	5
安裝方法	6
使用方法	7
使用及維護注意事項	7~8
維護方法	9
電氣原理圖	9
規格	末頁

Thank you for purchasing this KDK product.
Please read these instructions carefully before attempting to install, operate or service the KDK product. Please carefully read "INSTALLATION INSTRUCTIONS" (P.3~4) of this instructions before installation. Failure to comply with instructions could result in personal injury or property damage. Please explain to users how to operate and maintain the product after installation, and this booklet should be presented to users. Please carefully read "USE AND MAINTENANCE INSTRUCTIONS" (P.7~8) of this instructions before operation. Please retain this booklet for future reference.

感謝您選用KDK產品。

安裝、使用和保養KDK產品前，請仔細閱讀本安裝使用說明書。安裝前，請務必先閱讀“安裝注意事項”（第3~4頁）。不遵照此說明書進行操作有可能導致人員受傷或財產損失。安裝完成後，請向顧客說明如何使用和維護KDK產品，並將此說明書交給顧客保管。使用前，請務必先閱讀“使用及維護注意事項”（第7~8頁）。請妥善保管好此說明書以備日後參考。

SAFETY INSTRUCTIONS

安全指引

Please observe strictly

請務必遵守

- Disconnect power supply before maintenance.
維護保養前先斷電。
- If the supply cord is damaged, it must be replaced by the manufacturer, its service agent or similarly qualified persons in order to avoid a hazard.
如果電源軟線損壞，為了避免危險，必須由製造商、其維修部或類似部門的專業人員更換。
- This appliance is not intended for use by persons (including children) with reduced physical, sensory or mental capabilities, or lack of experience and knowledge, unless they have been given supervision or instruction concerning use of the appliance by a person responsible for their safety. Children should be supervised to ensure that they do not play with the appliance.
本產品不適合有殘疾、智障或精神障礙的人士或缺乏經驗、常識者(包括兒童)維護使用，除非在負責他們安全的人士的看護或指導下使用。兒童應該有人進行看護，以防將產品當做玩具。

The following instructions should be strictly observed in order to prevent injury to the users and other people, or damage to property.

為避免給您及其他人造成傷害，這裡我們列出了以下安全注意事項，請務必遵守，各種標誌的含意請參見以下內容。

- The degrees of injury or damage that can occur when the instructions are ignored and if the product is not used properly have been classified and described by the following indications.
對無視表示內容，錯誤地使用時，會引起的危害或損傷的程度，用下列符號進行分類、說明。



WARNING
警告

This indication means: Must be treated seriously that this may result in death or serious injury.

本標誌所表示內容為“不遵守的話可能造成人員死亡或重傷”。



CAUTION
注意

This indication means: Must be treated seriously that this may result in injury or physical damage.

本標誌所表示內容為“不遵守的話可能造成人身輕傷或其他財產損害”。

- Types of instructions that should be observed have been classified and described by the following pictorial symbols.
對希望遵守的內容和種類，用下列符號進行分類、說明。

SAFETY INSTRUCTIONS

安全指引

Please observe strictly

請務必遵守



This symbol indicates the item is "PROHIBITED" to do.
此標誌表示為禁止事項



This symbol indicates the "COMPULSORY" item that must be followed without failure.
此標誌表示為強制事項



This symbol indicates the item is "CAUTION".
此標誌表示為提示注意事項

INSTALLATION INSTRUCTIONS

安裝注意事項



WARNING

警告

- Do not operate the product other than the rated voltage (220 V~ 50 Hz).

禁止使用額定電壓(220 V~ 50 Hz)以外的電壓。



Otherwise, it may cause damages to the product or a fire.

否則可能會損壞本產品或導致火災。

- Installation should be done by authorized person. (Wiring is required to follow the local wiring regulations.)

安裝必須由專業人員完成。(產品安裝必須符合當地的安全法規。)



Otherwise, a fire may be caused.

否則可能會導致火災。

- Do not install the product as the method which is not approved in the instruction.

禁止使用本說明書指定以外的方法進行安裝。



Otherwise, unreliable installation may be caused and thus the product may fall off, resulting in injuries.

否則可能會安裝不牢固，導致產品掉落受傷。

- Do avoid the back-flow of gas into the room from the open flue of flammable gas or other open-fire appliances.

必須避免易燃氣體從敞開的氣道或其他燃燒燃料的設備回流進室內。



Otherwise, a fire may be caused.

否則可能會導致火災。

INSTALLATION INSTRUCTIONS

安裝注意事項



CAUTION

注意

- Do not reconstruct this product.

禁止對本產品進行改造。



Otherwise, it may cause damage to the product or personal injury.

否則可能會導致產品損壞或受傷。

- The special-purpose or dedicated parts, such as mounting fixtures, must be used if such parts are provided.

有安裝五金件等專用零部件時，應使用專用零部件。



Otherwise, it may fall off to cause personal injury.

否則可能會掉落，導致受傷。

- The glasses which are used to installed product must have sufficient installation strength and support more than 5 times weight of the product. They must be reinforced if their strength can not be sure.

安裝產品的玻璃必須要有足夠的安裝強度，確保有能承載大於產品重量5倍的強度。如不能確保安裝強度，請務必採取加固措施。



Otherwise, it may fall off to cause personal injury.

否則可能會掉落，導致受傷。

- Install this product over 2.3 m above the floor.

產品安裝高度距地面必須大於 2.3 m。



>2.3 m

Avoiding any accidents
防止意外

INSTALLATION REQUIREMENTS

安裝要求

- Do not install this fan where it could be directly exposed to water or excess vapor.

請勿把換氣扇安裝在容易被水噴到或煙霧、水氣過多的地方。



- Do not install this fan in the ceiling.

請勿把換氣扇安裝在天花板上。

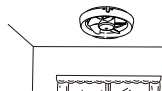

INSTALLATION REQUIREMENTS

安裝要求

- Do not install this fan over cooking equipment.
請勿把換氣扇安裝在烹調設備上方。



- Be sure to provide an appropriate opening for air intake.
安裝場所必須設置有通風口。



- Do not install this fan in dusty environment.
請勿把換氣扇安裝在灰塵較多的場所。
- This fan can be mounted in outside faced window from inside of room.
此換氣扇可以從室內安裝在窗戶上。

PART NAMES AND DIMENSIONS

部件名稱和尺寸

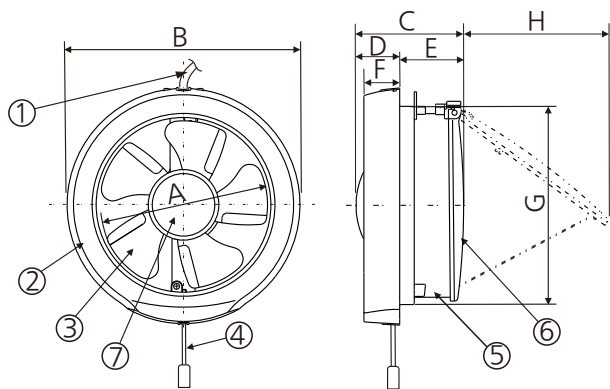

1	Power cord	電源線
2	Orifice	面罩
3	Blade assembly	扇葉組合
4	Pull cord of switch	開關拉繩
5	Body	機身
6	Shutter	風簾
7	Spinner	旋鈕

Unit: mm
尺寸單位: 毫米

Model 型號	A	B	C	D	E	F	G	H
15WUF 07	Ø150	Ø210	97	43	54	37.4	177	149
20WUF 07	Ø200	Ø271	98	36	62	36	237	201

HOW TO INSTALL 安裝方法

1. Make an installation hole on the window glass according to the dimensions showed in the table.
在玻璃窗上按表中所示的尺寸開一個安裝孔。

Unit: mm
單位: 毫米

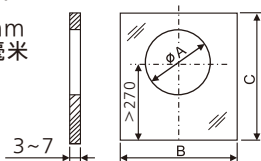

Model No. 型號	A	B	C
15WUF07	186~188	≥250	≥400
20WUF07	247~250	≥300	≥420

2. Mount the supplied plastic gasket making sure that the seam is on the upper half (either left side or right side) of the hole, never positioned on the vertical center part. Adjust the length so that there is no gap at the joint.

把安裝膠墊固定，請務必把接口固定在孔的左上端或右上端，不要把接口固定在中央位置，請調整安裝膠墊的長度使接口之間沒有間隙。

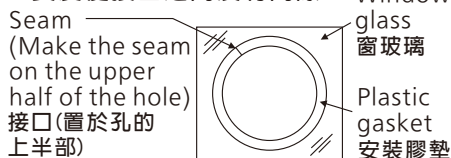

3. Please seal the gap between glass and gasket by silicon sealant to ensure the airtightness.

然後用玻璃膠填滿玻璃與安裝膠墊之間間隙，以確保其密封性。

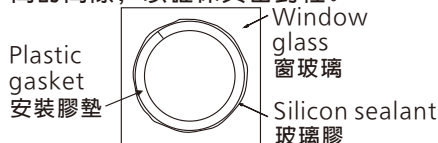

4. Loose 2 pieces of orifice screw and remove the orifice.

鬆開換氣扇2顆面罩螺絲，取下面罩。



5. When installing the fan, fix top of the fan at the window glass (figure ①), and press the bottom of the fan into the hole (figure ②), then push the fan in the hole downward, and tighten the fixing screw afterwards (figure ③).

在安裝換氣扇時，先把換氣扇頂部固定在窗玻璃上(圖①)再把換氣扇的下部壓入孔中(圖②)，然後把換氣扇向下壓。安裝好後擰緊安裝螺釘(圖③)。

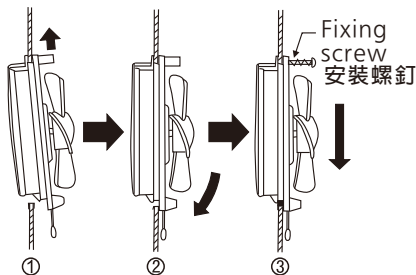

6. Set the orifice (figure ①) and secure 2 pieces of orifice screw (figure ②).

把面罩安裝好(圖①)，擰緊2顆面罩螺釘(圖②)。

⊘ Do not operate this ventilating fan before setting the orifice.

在面罩沒有安裝好之前不可以運轉本產品。



HOW TO USE 使用方法

Turn on the fan 開啟

- ① Pull the pull cord of switch outward to release the knot from fan.
向外拉開關拉繩，使繩結脫離卡口位。
- ② Release the pull cord of switch slowly to open the shutter, power supply will be connected and the fan will operate in the meantime
緩慢釋放拉繩，使風簾打開，此時電源接通換氣扇運轉。

Turn off the fan 關閉

Pull the pull cord of switch downward to lock the knot at the fan, the power supply will be disconnected and the fan will stop in the meantime.
向下拉開關拉繩，使繩結置於卡口位，此時電源切斷，換氣扇停止運轉。

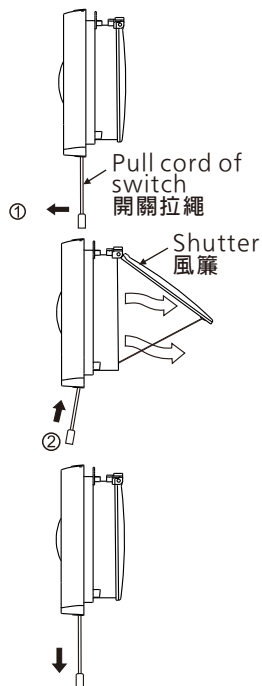

USE AND MAINTENANCE INSTRUCTIONS 使用及維護注意事項



WARNING

警告

- Before touching the main body of this product or cleaning this product, make sure that the "all-pole switch" connected to this product is disconnected.

在接觸本產品機體前和清潔本產品時，必須確保連接本產品的“電源全極開關”處於斷開狀態。



Otherwise, may lead to electric shock.
否則可能會觸電。

- If you will not use this product any more, remove the product.

如以後不打算再使用本產品時，不得放置不管，而應予以拆除。



This product may cause injuries once it falls off.
萬一掉落，可能會導致受傷。

USE AND MAINTENANCE INSTRUCTIONS

使用及維護注意事項

WARNING 警告

- Do not disassemble this product for repair or reconstruction.
禁止拆解本產品進行修理或改造。



Doing this may lead to fire and electric shock.
容易導致火災、觸電。

CAUTION 注意

- Please wear the gloves when cleaning the product.
清潔時請帶上手套。



Otherwise, it may cause damage.
否則可能會導致受傷。

Cleaning Precautions 清潔提示事項

- Disconnect the power supply until blade is completely stopped before clean and maintenance.(Figure 1)
在清潔保養前請確保斷開電源且扇葉停止運動。(圖1)
- Never use petrol, benzene thinner or any other such chemicals for cleaning the product.
請勿使用汽油、苯、稀釋劑或其他諸如此類的化學品擦拭換氣扇。(圖2)
- Do not allow water to contact electrical parts such as motor.(Figure3)
電動機等電氣部件絕對不能被水接觸。(圖3)
- Never immerse blade or other resin parts in hot water over 60 °C.
請勿把塑膠部品浸入高於60 °C的水中。(圖4)

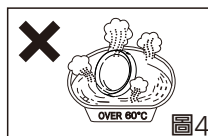
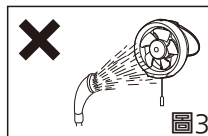
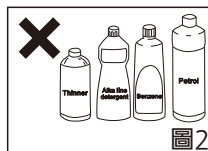
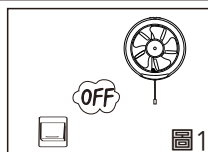

MAINTENANCE

維護方法

1. Turn the cap with counter-clockwise direction, then take out the blade.

逆時針方向旋轉旋蓋，並向外取出扇葉。

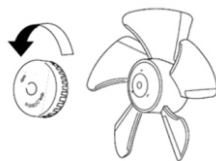

2. Cleaning the blade with clear water.

使用清水對扇葉進行清潔。



3. Dry the blade and reinstall it into product, then turn clockwise to tighten the cap.

將扇葉擦乾，重新裝入機體，順時針方向旋轉扭緊旋蓋。

WIRING DIAGRAM

電氣原理圖

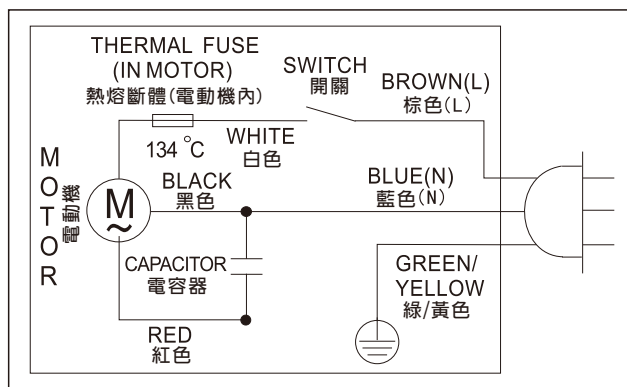

SPECIFICATIONS

規格

Model 型號	Voltage 電壓 [V]	Frequency 頻率 [Hz]	Power consumption 耗電量 [W]	Air delivery 排氣量 [m ³ /min]	Power factory 功率因數 [%]	Noise 噪音 [dB]	Net Weight 淨重 [kg]
15WUF ₀₇	220	50	7.7	3.5	95	34	0.9
20WUF ₀₇	220	50	17	7	98	39	1.2

1. The values are specified at the static pressure of 0 Pa.
 2. The values of noise level is A weighted average sound pressure level, the mean value measured by our company, within +3 and -7dB tolerance.
 3. The values of noise level are measured at 1.0 m apart from front and side of the fan body.
 4. The values of air volume are the mid-points of results measured by our company, with $\pm 10\%$ tolerance.
1. 排氣量、電氣特性、噪音值等資料是在靜壓為0 Pa狀態下的數值。
 2. 噪音值是A計權平均聲壓級，是本公司測試結果的中心值，有+3 dB，-7 dB的公差範圍。
 3. 噪音是指最大風量作用時，在本體前面、側面1.0 m處的噪音值。
 4. 排氣量是本公司測試排氣量結果的中心值，有 $\pm 10\%$ 的公差範圍。

* Air direction: Exhaust 氣流方向：排氣
IPX4(outside) IPX4(戶外部分)
Insulation class E E級絕緣